

# Alice

SITS



# Alice

*auten*

designed by: Dan Ihreborn



## UPHOLSTERY



fabric

## COMFORTS



lux

## COVERS



fixed

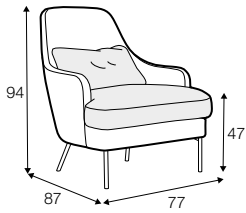

armchair

## extra dimensions

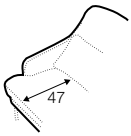

depth of seat

## legs

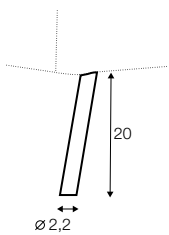

no. 162A  
metal painted  
black  
or brass gold  
front: armchair

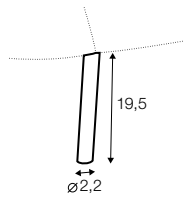

no. 160D  
metal painted  
black  
or brass gold  
back: armchair

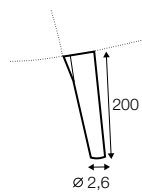

no. 212  
wood  
front

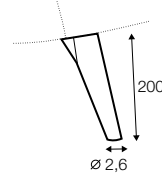

no. 212A  
wood  
back

## profile

---

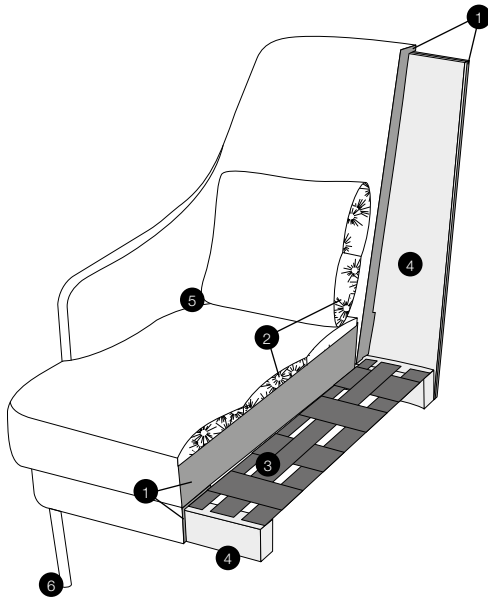

### lux

1. polyurethane foam/ high resilient polyurethane foam
2. cushion chamber with of feather
3. upholstery belts
4. solid wood and wood based element
5. fabric
6. metal or solid wood legs