

Flynn

SITS



Flynn

designed by: Steven Schilte



UPHOLSTERY



fabric

COMFORTS



LUX lux

COVERS



LCV loose with velcro

SPECIAL



modular system

All elements are freestanding.

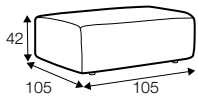

footstool 105x105

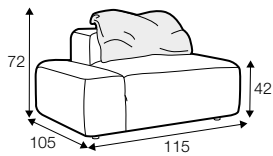

element 115 left or / right with back cushion 75x65

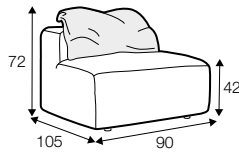

element 90 without armrests with back cushion 75x65

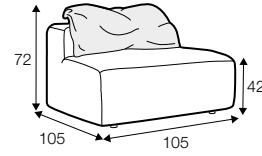

element 105 without armrests with back cushion 90x65

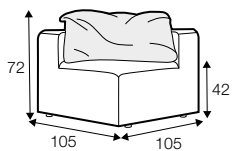

corner 90° with back cushion 90x65

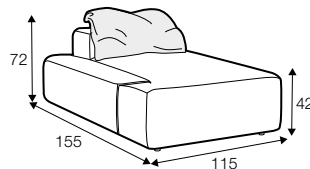

chaiselongue left or / right with back cushion 75x65

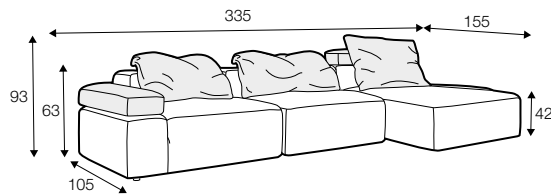

example set

element 115 left / or right with back cushion 75x65
+ armrest / headrest 103 + element 105 without armrests with back cushion 90x65 + chaiselongue right / or left with back cushion 75x65 + armrest / headrest 88

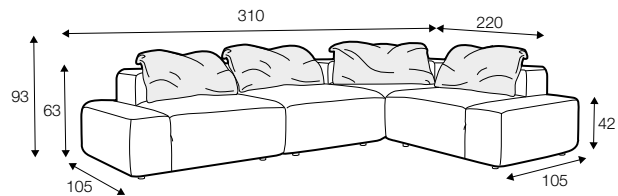

example set

element 115 left with back cushion 75x65
+ element 90 without armrests with back cushion 75x65
+ corner 90 with back cushion 90x65 + element 115 right with back cushion 75x65

extra dimensions

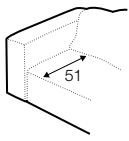

depth of seat

accessories

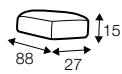
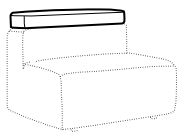
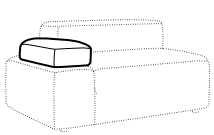

armrest / headrest 88

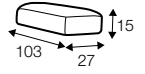
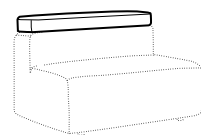
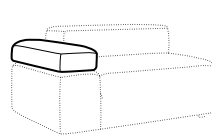

armrest / headrest 103

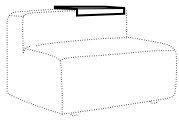
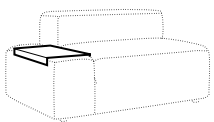

metal tray 50x27
soft touch, black



back cushion 75x65



back cushion 90x65

legs

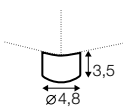

no. 173
wood

profile

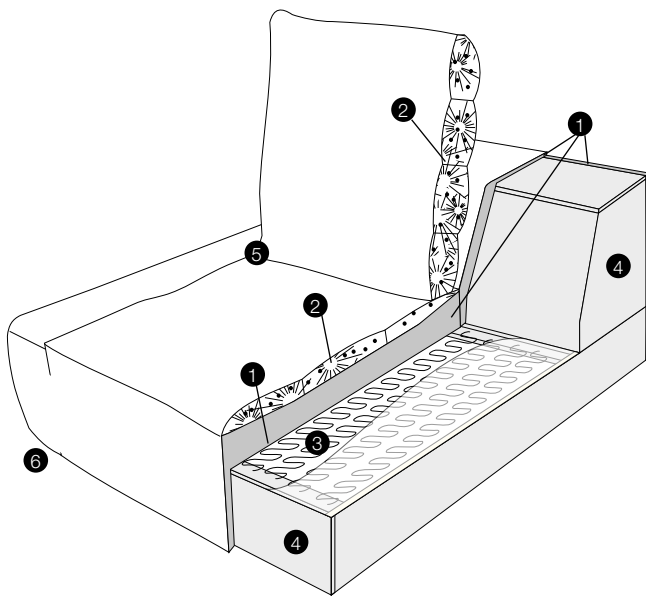

lux

1. polyurethane foam/high resilient polyurethane foam
2. cushion chamber with mix of feather and silicone balls
3. springs
4. solid wood and wood based elements
5. fabric
6. solid wood or metal legs