

# Palma

# SITS



# Palma

UPHOLSTERY

COMFORTS

COVERS

SPECIAL



fabric



STD standard



PLUS plus



FC fixed



modular system

Drawings show combinations with armrest 1000. Combinations with other are properly longer or shorter in width.

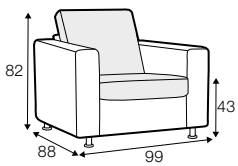

armchair

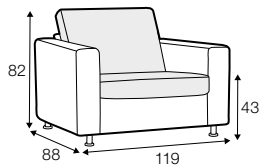

armchair wide

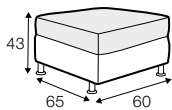

footstool 65x60

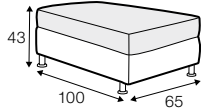

footstool 100x65

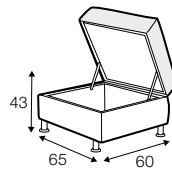

footstool box 65x60

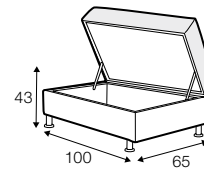

footstool box 100x65

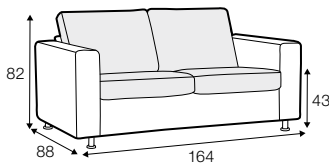

2 seater

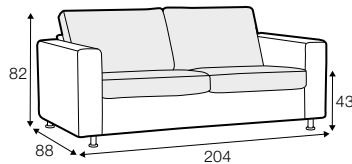

2,5 seater

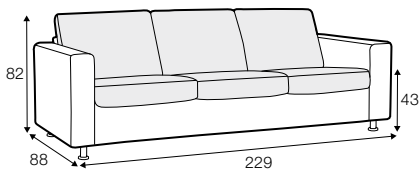

3 seater  
with 3 seat cushions

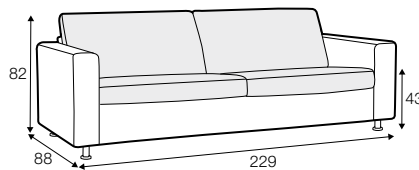

3 seater  
with 2 seat cushions

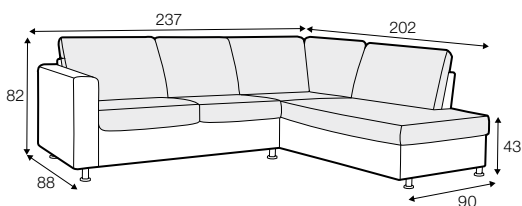

set 5 right / or left  
2 seater left / or right + divan right / or left

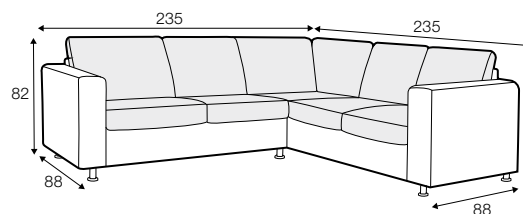

set 6  
2 seater left + corner 90° + 2 seater right

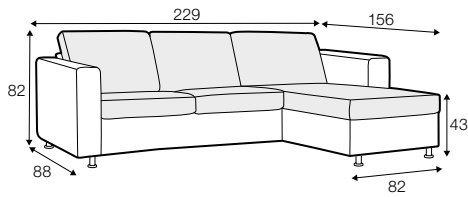

set 7 right / or left  
2 seater left / or right + chaiselongue right / or left

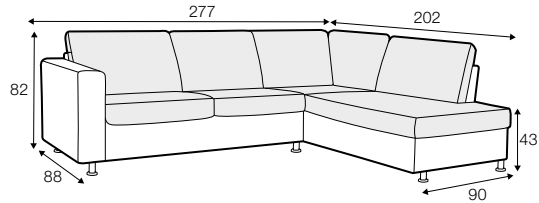

set 8 right / or left  
2,5 seater left / or right + divan right / or left

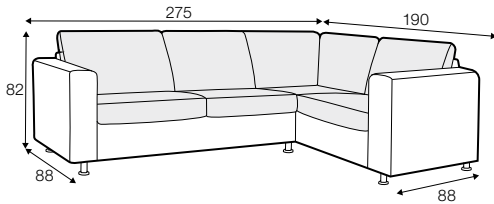

set 11 right / or left  
2,5 seater left / or right + corner 90°  
+ armchair wide right / or left

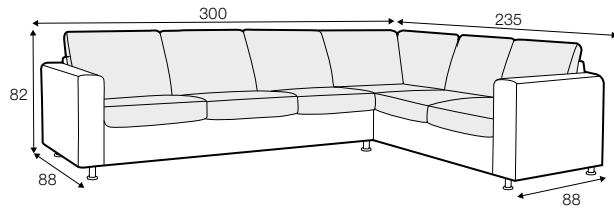

set 16 right / or left (corner 32/23)  
3 seater with 3 seat cushions left/ or right + corner 90°  
+ 2 seater right / or left

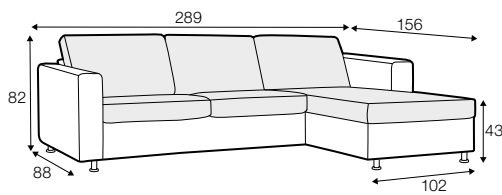

set 21 right / or left  
2,5 seater left / or right + chaiselongue wide right / or left

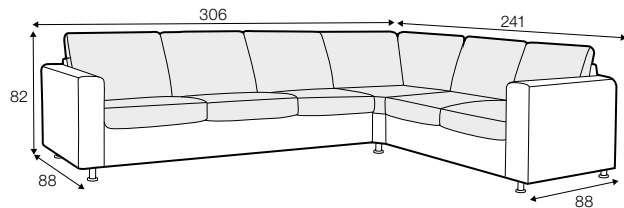

set 22 right / or left  
3 seater with 3 seat cushions left/ or right + corner 90° no 2  
+ 2 seater with 2 seat cushion right / or left

## modular system

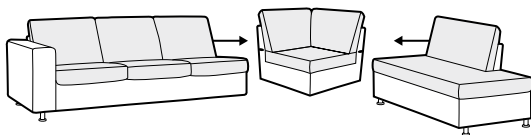

## elements of the modular system

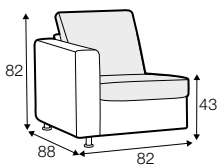

armchair  
left / or right

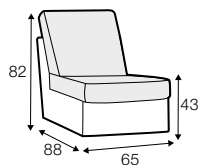

armchair  
without armrests

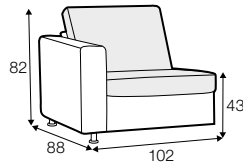

armchair wide  
left / or right

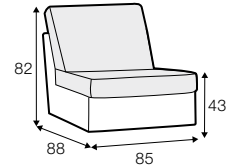

armchair wide  
without armrests

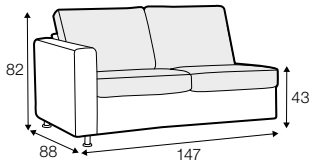

2 seater left / or right

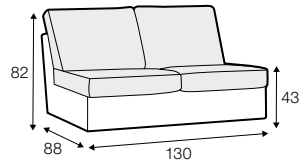

2 seater without armrests

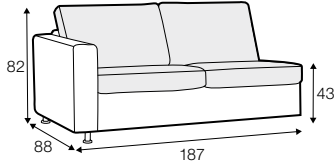

2,5 seater left / or right

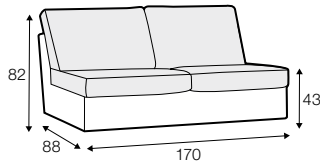

2,5 seater without armrests

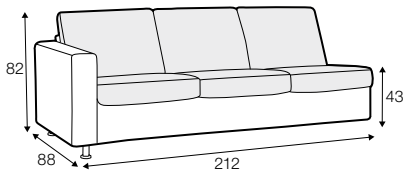

3 seater left / or right  
with 3 seat cushions

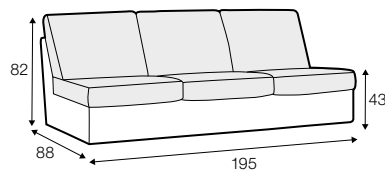

3 seater without armrests  
with 3 seat cushions

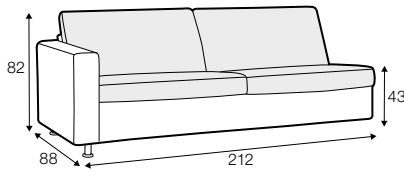

3 seater left / or right  
with 2 seat cushions

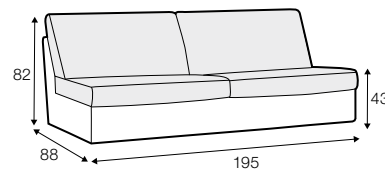

3 seater without armrests  
with 2 seat cushions

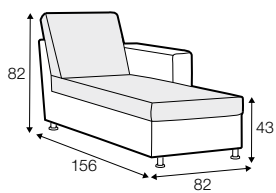

chaiselongue right / or left

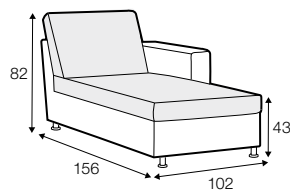

chaiselongue wide  
right / or left

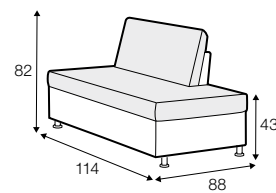

bench right / or left

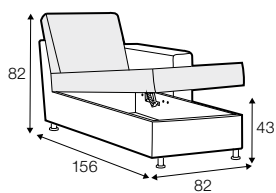

chaiselongue  
box right / or left

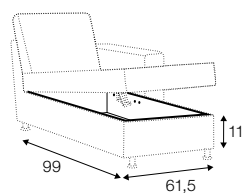

box dimensions  
chaiselongue

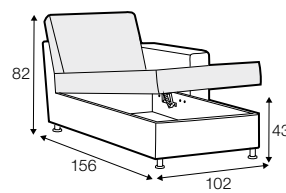

chaiselongue wide  
box right / or left

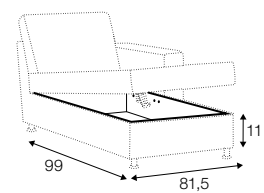

box dimensions  
chaiselongue wide

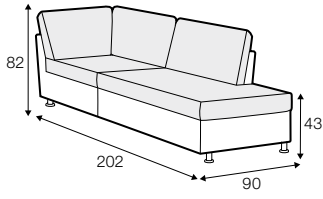

divan right / or left

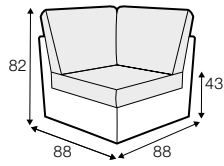

corner 90°

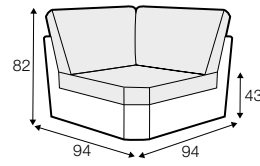

corner 90° no 2

**extra dimensions**

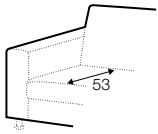

depth of seat

**accessories**

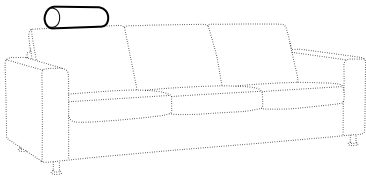

headrest with roll L-50

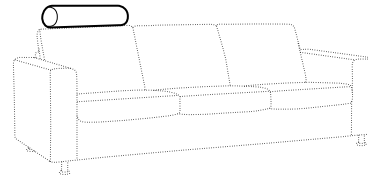
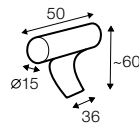

headrest with roll L-78

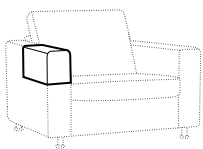
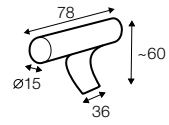

armrest protection

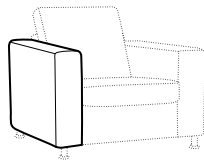

armrest 1000

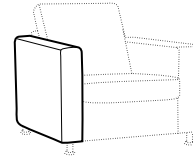

armrest 6000

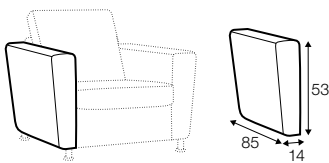

armrest 7000

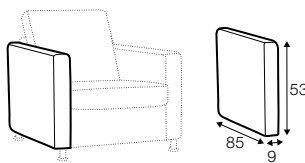

armrest 8000

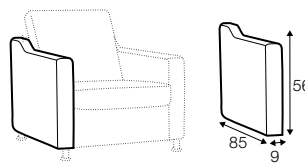

armrest 8100

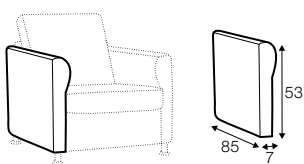

armrest 8200

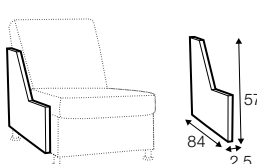

armrest 9000

## legs

---

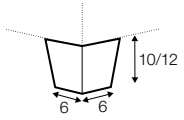

no. 19  
wood

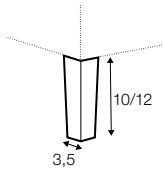

no. 109  
wood

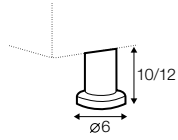

no. 03  
metal chrome,  
painted black

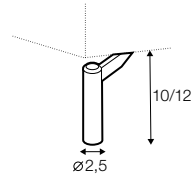

no. 145B  
metal chrome,  
painted black



## profile

---

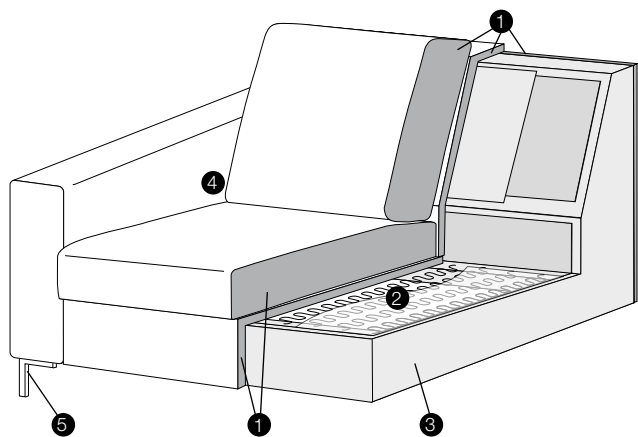

### standard

1. polyurethane foam/high resilient polyurethane foam
2. springs
3. solid wood and wood based elements
4. fabric
5. solid wood/metal legs

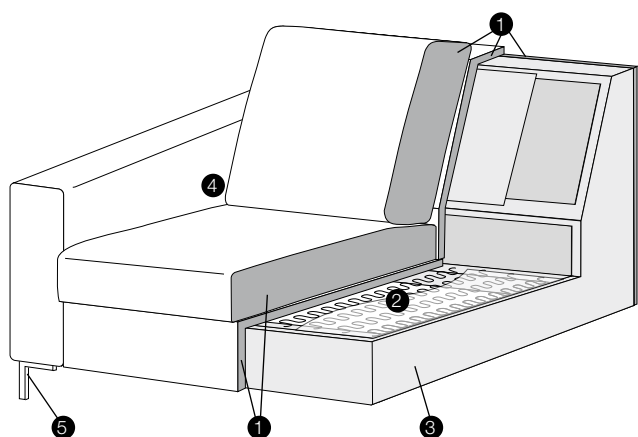

### plus

1. polyurethane foam/elastic soft high resilient polyurethane foam polyure
2. springs
3. solid wood and wood based elements
4. fabric
5. solid wood/metal legs