

# Viktoria

# SITS



# Viktoria

UPHOLSTERY

COMFORTS

COVERS

SPECIAL



fabric



LUX lux



LC loose



LCV loose with velcro



modular system

All drawings shown height with leg no. 12 H-8.

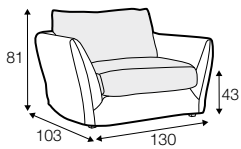

armchair

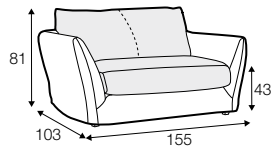

armchair wide

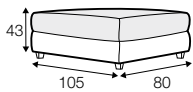

footstool 105x80

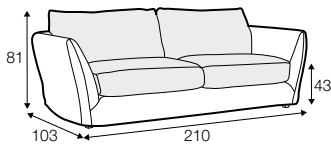

2 seater

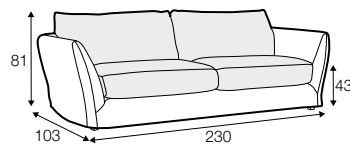

2,5 seater

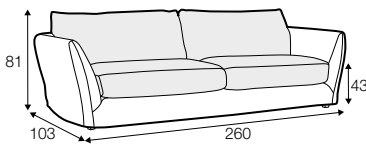

3 seater / or 3 seater divided

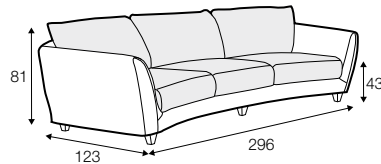

3 seater round divided

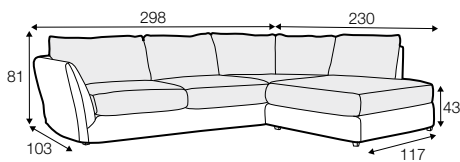

set 1 right / or left

2 seater left / or right + divan right / or left

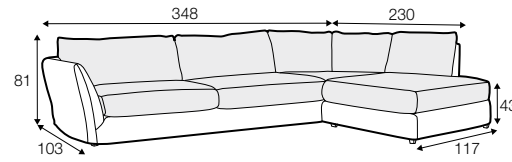

set 2 right / or left

3 seater left / or right + divan right / or left

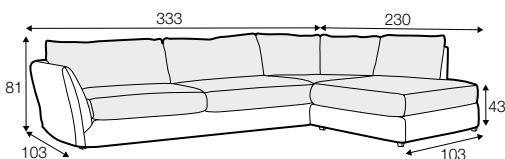

set 5 right / or left

3 seater left / or right + corner 90° + bench right / or left

**modular system**

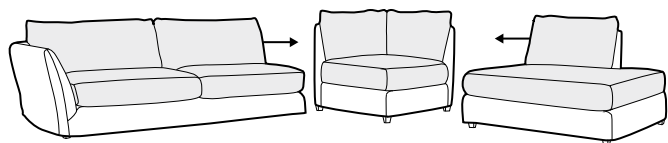

**elements of the modular system**

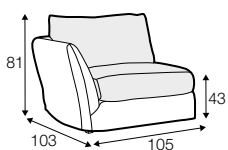

armchair left / or right

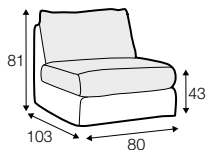

armchair without armrests

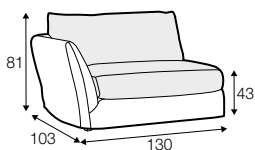

armchair wide left / or right

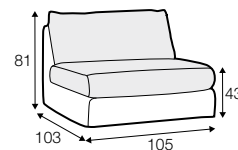

armchair wide without armrests

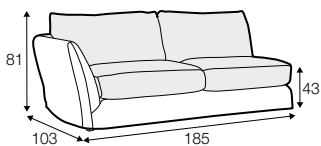

2 seater left / or right

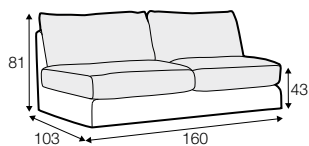

2 seater without armrests

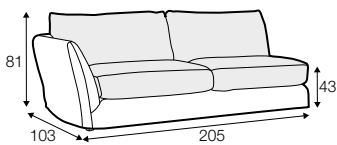

2,5 seater left / or right

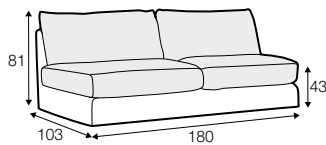

2,5 seater without armrests

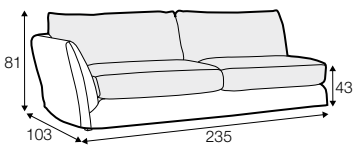

3 seater or 3 seater divided left / or right

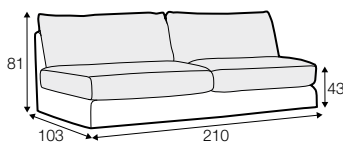

3 seater or 3 seater divided without armrests

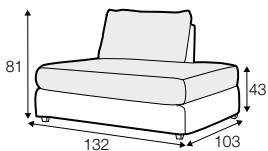

bench right / or left

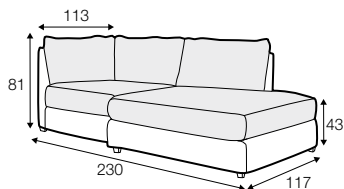

divan right / or left  
divan right / or left divided

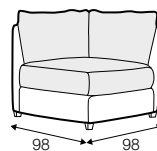

corner 90°

## extra dimensions

---

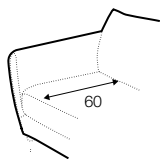

depth of seat

## extra dimensions

---

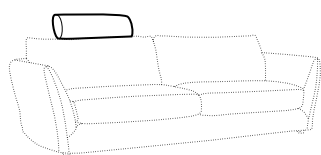

headrest L-62

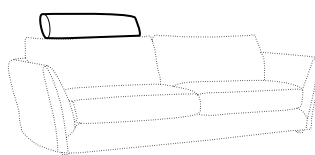
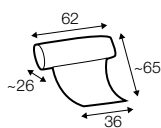

headrest L-77

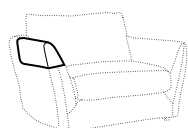
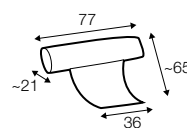

armrest protection

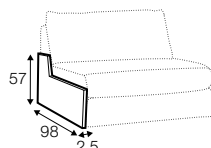

endpart left / or right

## legs

---

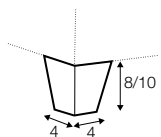

no. 12  
wood

## profile

---

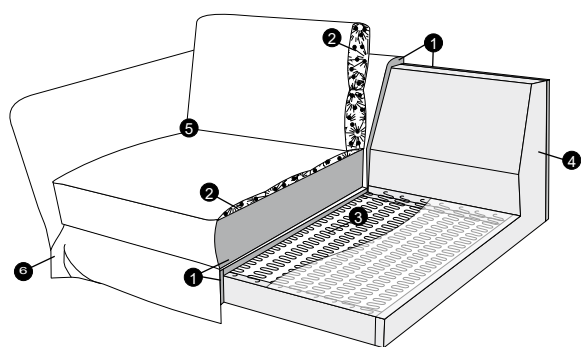

### lux

1. polyurethane foam/high resilient polyurethane foam
2. cushion chamber with mix of feather and silicone balls
3. springs
4. solid wood and wood based elements
5. fabric
6. solid wood or metal legs