

Elis

SiTS



Elis

UPHOLSTERY



fabric

COMFORTS



STD standard



LUX lux



CLS classic

COVERS



FC fixed



LC loose

SPECIAL



modular system

Drawing show combinations with armrest A. Combinantons with other armrest are properly longer or shorter in width.

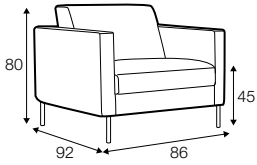

armchair

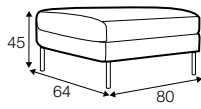

footstool 80x64

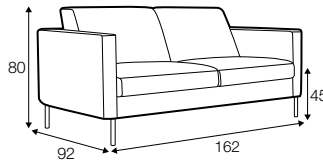

2 seater

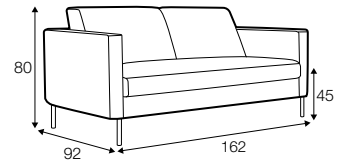

2 seater
with 1 cushion

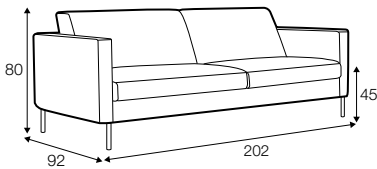

3 seater

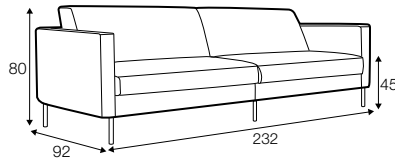

3,5 seater divided
with 2 cushions

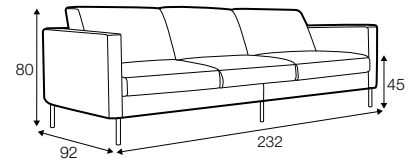

3,5 seater divided
with 3 cushions

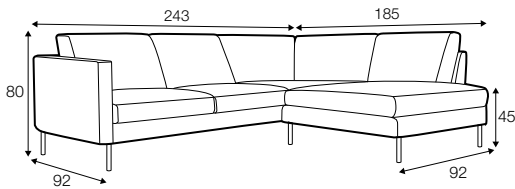

set 1 right / or left
2 seater left / or right + divan right / or left

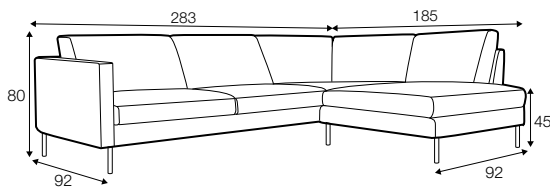

set 2 right / or left
3 seater left / or right + divan right / or left

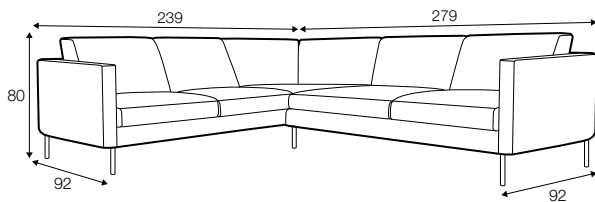

set 3 left / or right
2 seater left / or right + corner 90° + 3 seater right / or left

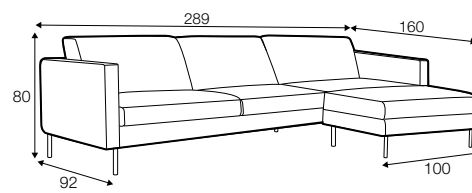

set 4 right / or left
3 seater left / or right + chaiselongue right / or left

modular system

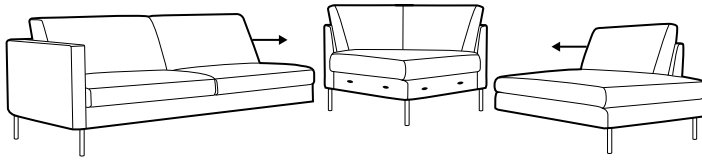

elements of the modular system

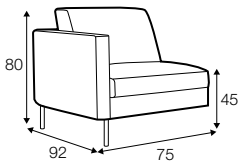

armchair left / or right

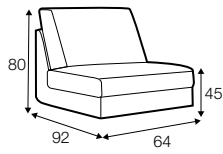

armchair
without armrests

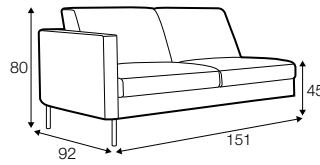

2 seater left / or right

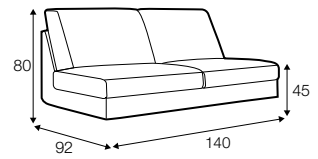

2 seater without armrests

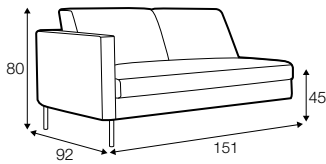

2 seater left / or right
with 1 cushion

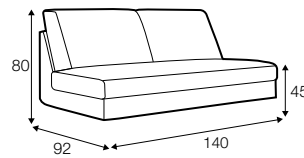

2 seater without armrests
with 1 cushion

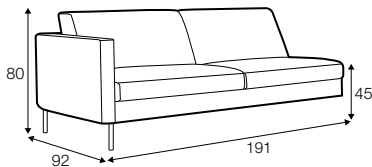

3 seater left / or right

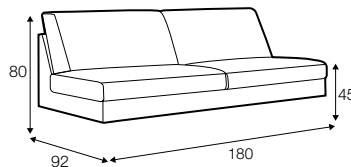

3 seater without armrests

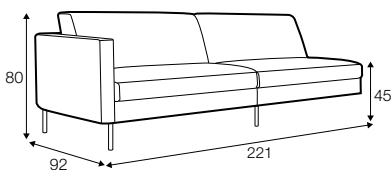

3,5 seater divided left / or right
with 2 cushions

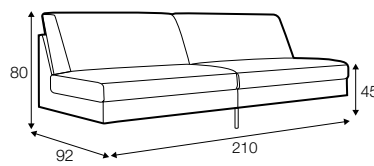

3,5 seater divided without armrests
with 2 cushions

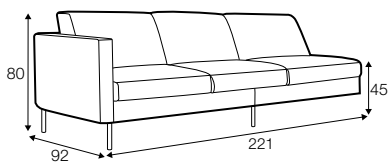

3,5 seater divided left / or right
with 3 cushions

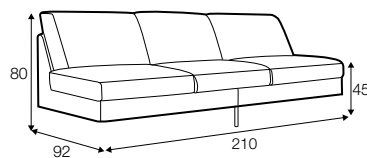

3,5 seater divided without armrests
with 3 cushions

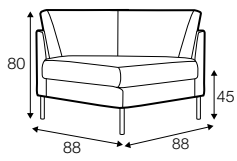

corner 90°

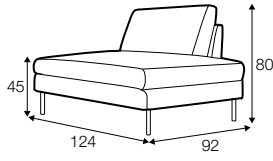

bench right / or left

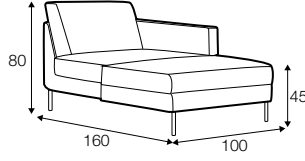

chaiselongue right / or left

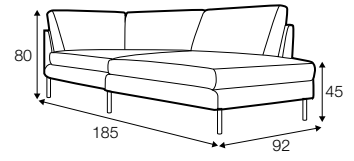

divan right / or left

extra dimensions

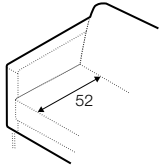

depth of seat

accessories

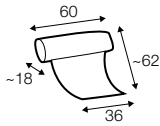
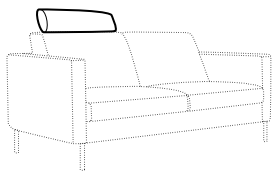

headrest L-60

recommended for armchair, 2 seater
3,5 seater with 3 seat cushions, bench,
corner, divan

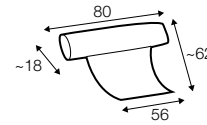
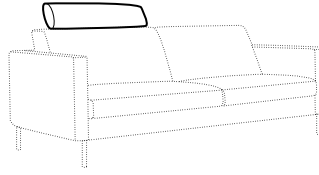

headrest L-80

recommended for 3 seater, divan

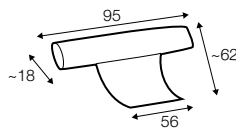
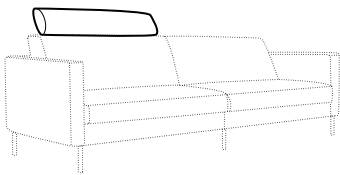

headrest L-95

recommended for 3,5 seater with 2 seat cushions

Headrest with french stitching are recommended form armrests A/B.
Headrest without french stitching are recommended form armrests C/D.

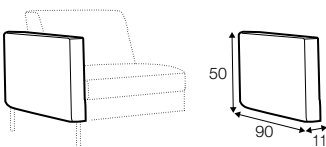

armrest A

french stitching on armrest
and back cushions

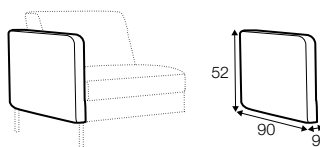

armrest B

french stitching on armrest
and back cushions

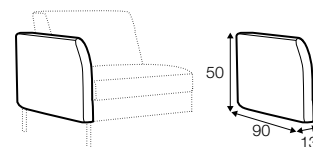

armrest C

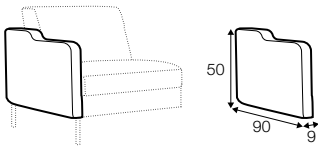

armrest D

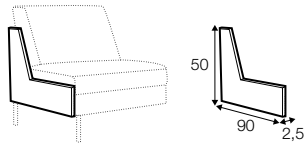

endpart left / or right

legs

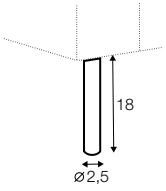

no. 177
metal painted black,
grey or white
recommended

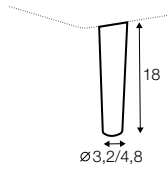

no. 141
wood

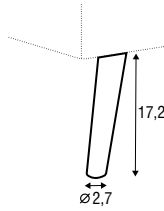

no. 154A
wood

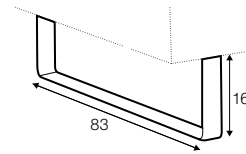

no. 104
metal painted black,
grey or white

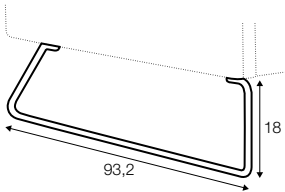

no. 179
metal painted black,
grey or white

There are two options to place the leg.

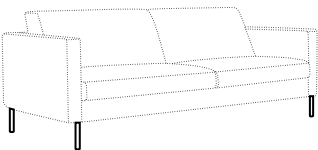

under armrest

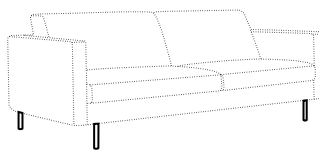

under frame

profile

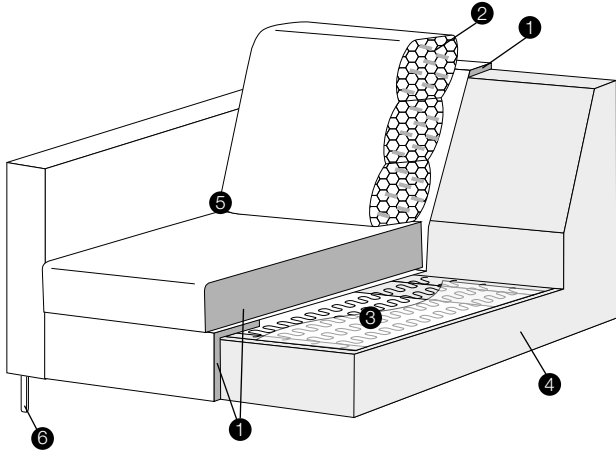

standard

1. polyurethane foam/ high resilient polyurethane foam
2. foam flakes with silicone balls
3. springs
4. FSC® certified solid wood and wood based elements
5. fabric
6. FSC® certified solid wood or metal legs

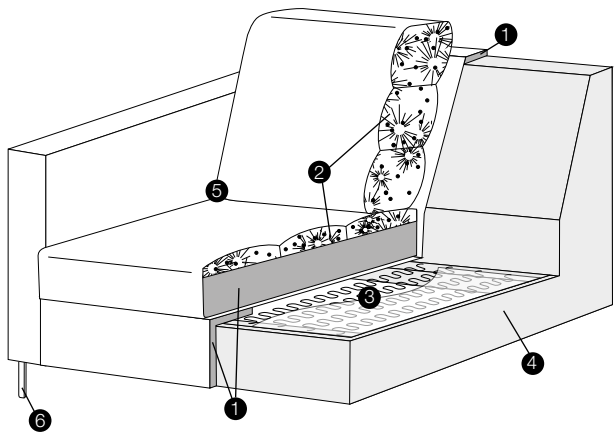

lux

1. polyurethane foam/ high resilient polyurethane foam
2. cushion chamber with mix of feather and silicone balls
3. springs
4. FSC® certified solid wood and wood based elements
5. fabric
6. FSC® certified solid wood or metal legs

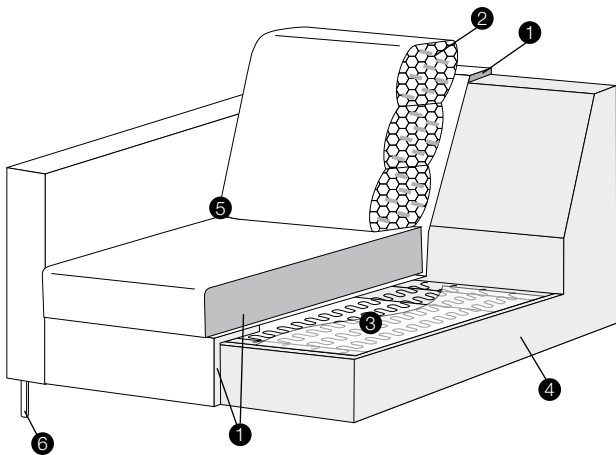

classic

1. polyurethane foam/ high resilient polyurethane foam
2. foam flakes with silicone balls
3. springs
4. FSC® certified solid wood and wood based elements
5. fabric
6. FSC® certified solid wood or metal legs