

Justus

SITS



Justus

Niels Gammelgaard

designed by: Niels Gammelgaard



UPHOLSTERY



fabric



leather

COMFORTS



STD standard



LUX lux



FC fixed

COVERS

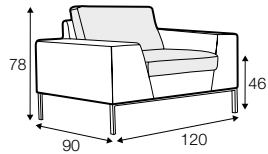

armchair

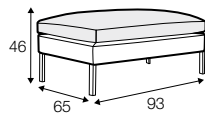

footstool 93x65

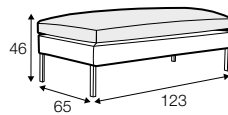

footstool 123x65

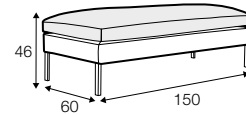

footstool 150x60

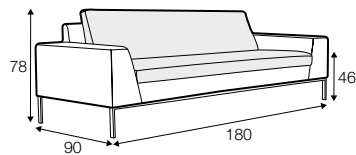

2 seater

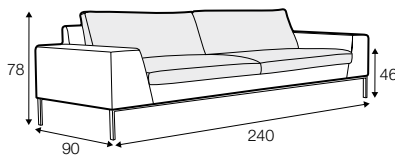

3 seater

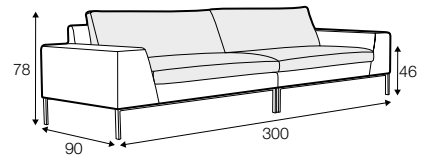

4 seater divided

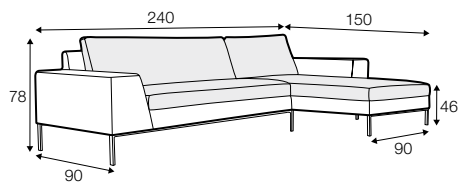

set 1 right / or left

2 seater left / or right + chaiselounge right / or left

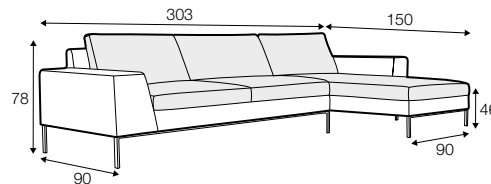

set 2 right / or left

3 seater left / or right + chaiselounge right / or left

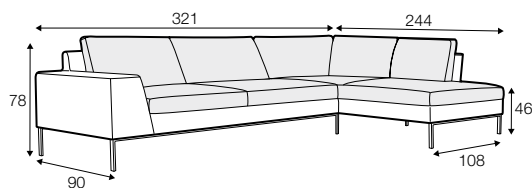

set 3 right / or left

3 seater left / or right + divan right / or left

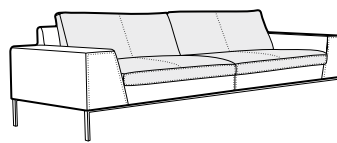

example of leather cover
4 seater

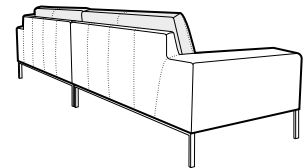

extra dimensions

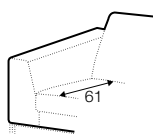

depth of seat

legs

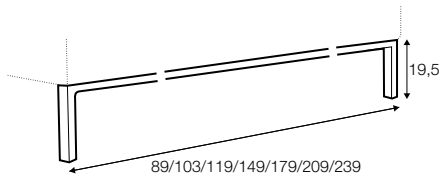

no. 83

metal chrome, painted black

profile

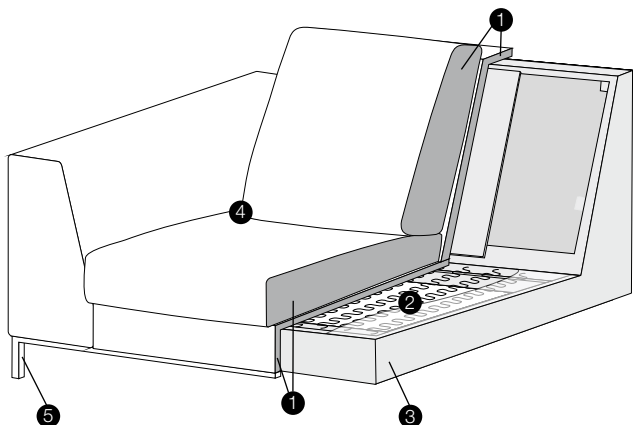

standard

1. polyurethane foam/ high resilient polyurethane foam
2. springs
3. solid wood and wood based elements
4. fabric or leather
5. metal legs

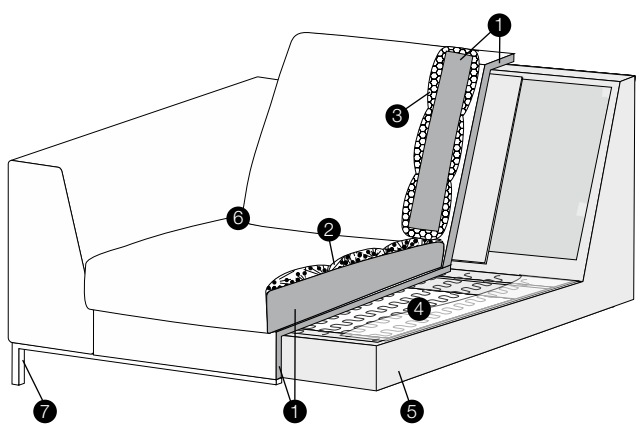

lux

1. polyurethane foam/ high resilient polyurethane foam
2. cushion chamber with mix of feather and silicone balls
3. silicone balls
4. springs
5. solid wood and wood based elements
6. fabric or leather
7. metal legs