

Vidar

SITS



Vidar

I. Archer
designed by: Ian Archer



UPHOLSTERY



fabric

COMFORTS



lux

COVERS



loose

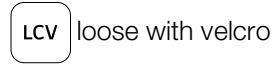

loose with velcro

SPECIAL



modular system

loose cover elements

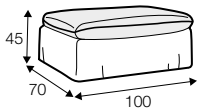

footstool 100x70

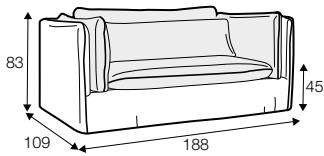

2 seater

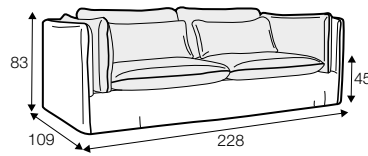

3 seater

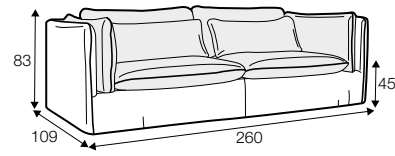

3,5 seater divided

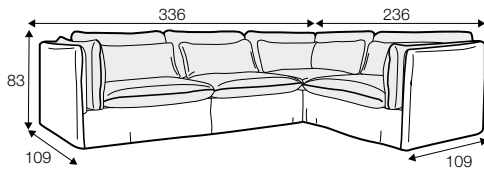

example of set

element 130 left / or right + element 100 without armrests
+ corner 90° + element 130 right / or left

loose cover with velcro elements

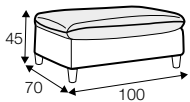

footstool 100x70

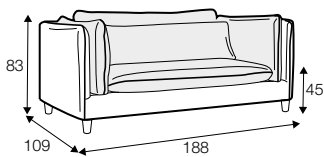

2 seater

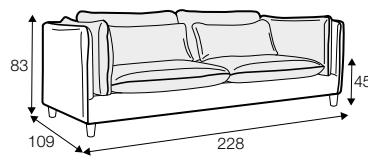

3 seater

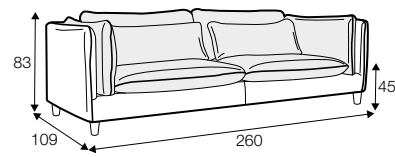

3,5 seater divided

modular system

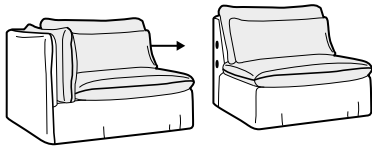

elements of the modular system loose cover

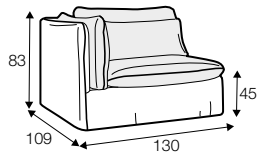

element 130
left / or right

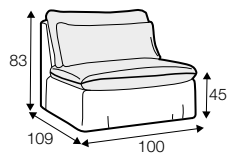

element 100
left / or right
without armrests

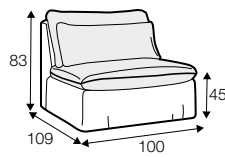

element 100
without armrests

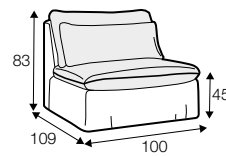

element 100
without armrests
freestanding

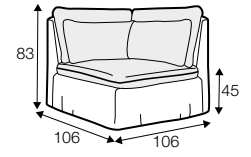

corner 90°

loose cover with velcro elements

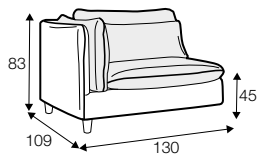

element 130
left / or right

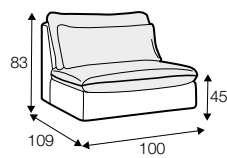

element 100
left / or right
without armrests

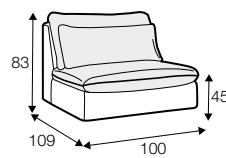

element 100
without armrests

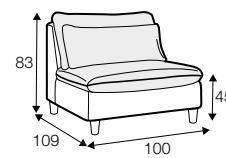

element 100
without armrests
freestanding

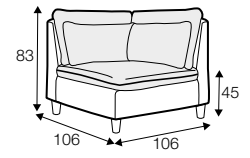

corner 90°

extra dimensions

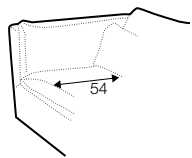

legs

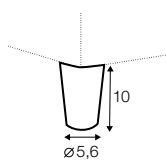

no. 58A
wood

profile

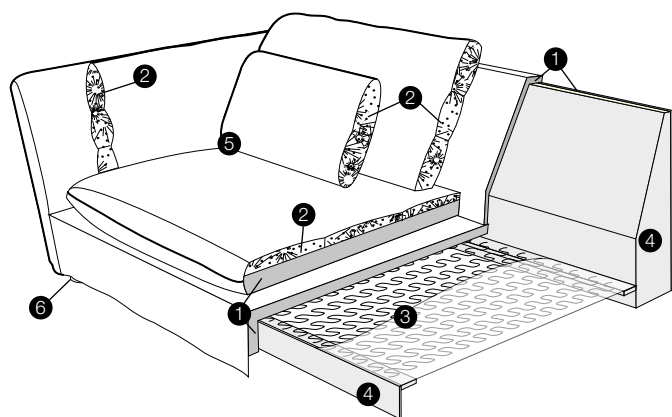

lux

1. polyurethane foam/ high resilient polyurethane foam
2. cushion chamber with mix of feather and silicone balls
3. springs
4. solid wood and wood based elements
5. fabric
6. solid wood legs