

Petra

SITS



Petra

UPHOLSTERY



fabric

COMFOTS



standard



classic



lux

COVERS



fixed



loose with
velcro

SPECIAL



modular
system

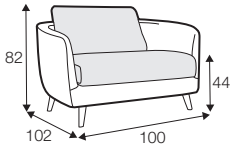

armchair

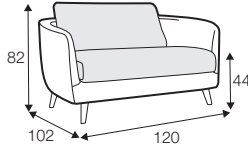

armchair wide

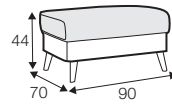

footstool 90x70

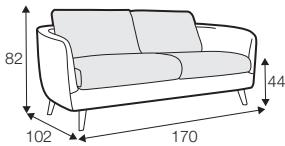

2 seater

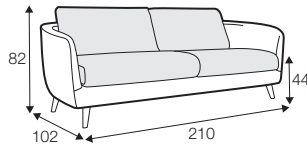

3 seater

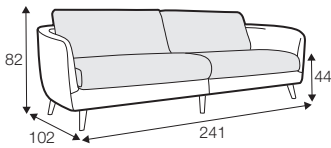

3XL seater divided
with 2 cushions

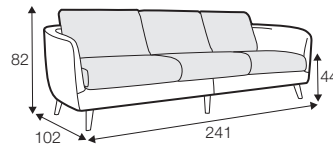

3XL seater divided
with 3 cushions

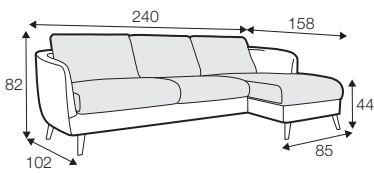

set 1 right / or left
2 seater left / or right
+ chaiselongue right / or left

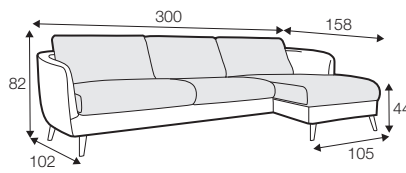

set 2 right / or left
3 seater left / or right
+ chaiselongue wide right / or left

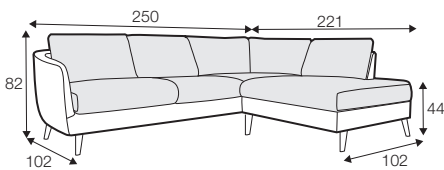

set 3 right / or left
2 seater left / or right
+ divan right / or left

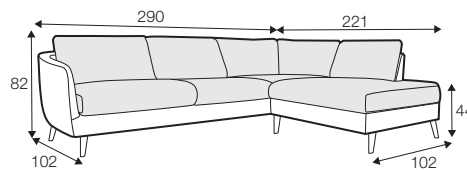

set 4 right / or left
3 seater left / or right
+ divan right / or left

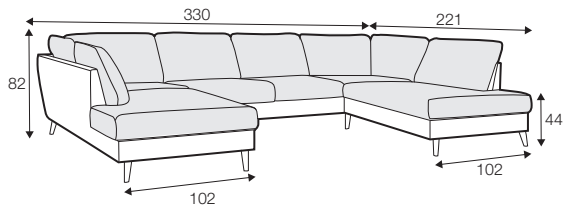

set 6
divan left + 2 seater without armrests + divan right

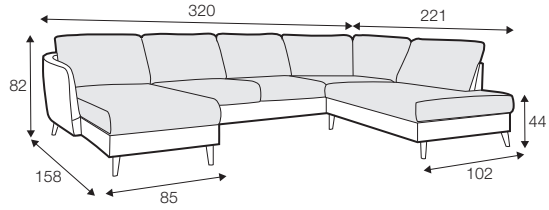

set 7 right / or left
chaiselongue left / or right + 2 seater without armrests + divan right / or left

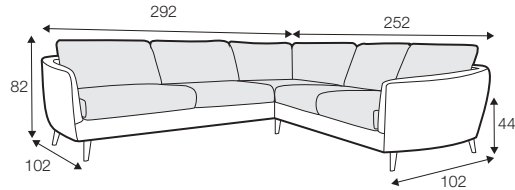

set 8 right / or left
3 seater left / or right + corner 90° no. 1 + 2 seater right / or left

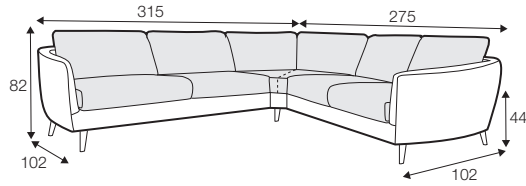

set 9 right / or left
3 seater left / or right + corner 90° no. 2 + 2 seater right / or left

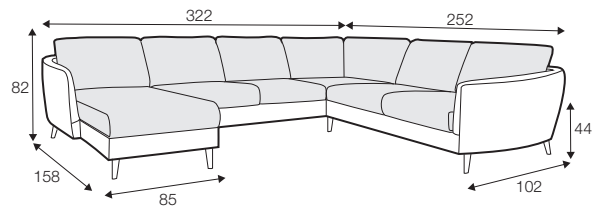

set 10 right / or left
chaiselongue left / or right + 2 seater without armrests + corner 90° no. 1 + 2 seater right / or left

modular system

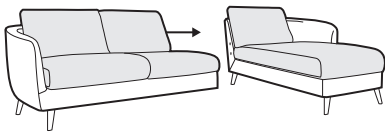

elements of the modular system

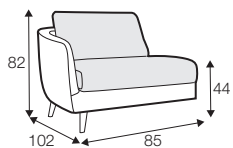

armchair left / or right

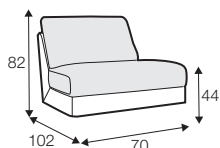

armchair without armrests

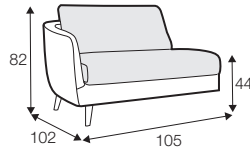

armchair wide left / or right

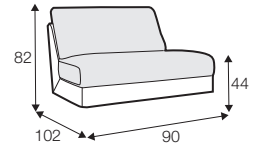

armchair wide without armrests

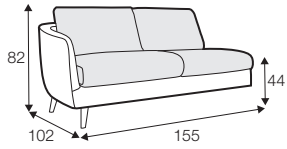

2 seater left / or right

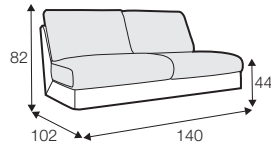

2 seater
without armrests

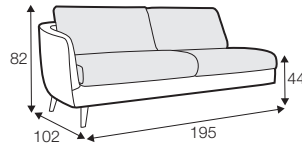

3 seater left / or right

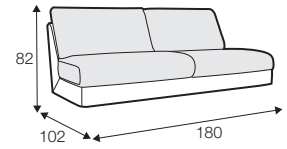

3 seater
without armrests

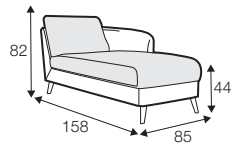

chaiselongue
right / or left

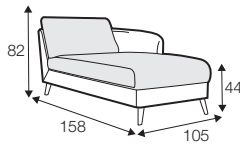

chaiselongue wide
right / or left

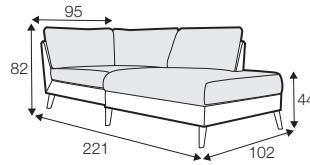

divane right / or left

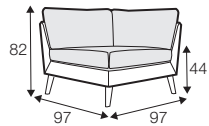

corner 90° no. 1

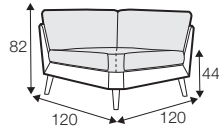

corner 90° no. 2

extra dimensions

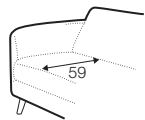

depth of seat

accessories

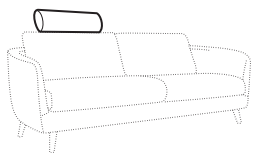

headrest L-62

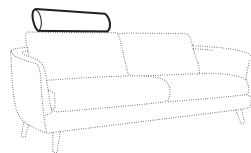
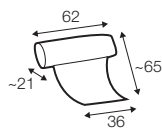

headrest L-77

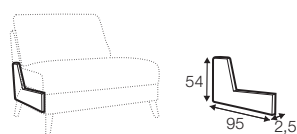
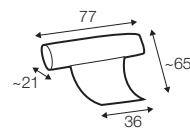

endpart left / or right

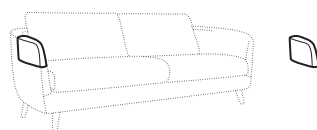

armrest protection

legs

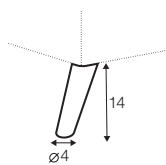

no. 141A
wood
recomended

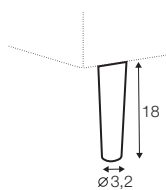

no. 141B
wood

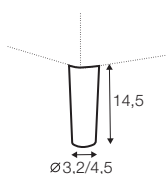

no. 153
wood

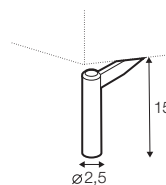

no. 145A
metal chrome,
painted black

profile

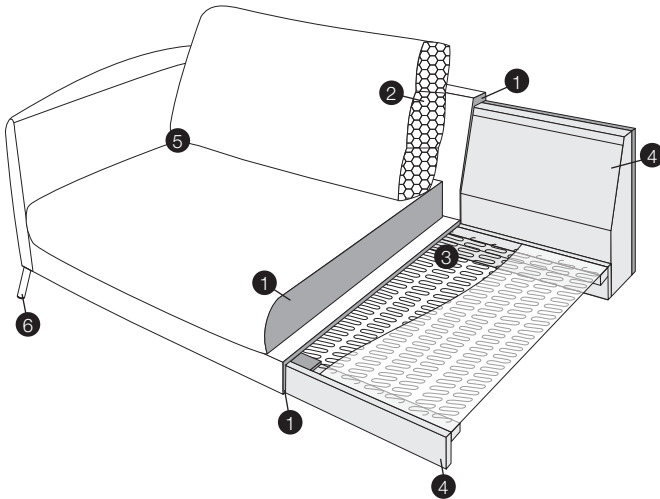

standard

1. polyurethane foam / high resilient polyurethane foam
2. silicone balls
3. springs
4. solid wood and wood based elements
5. fabric
6. solid wood or metal legs

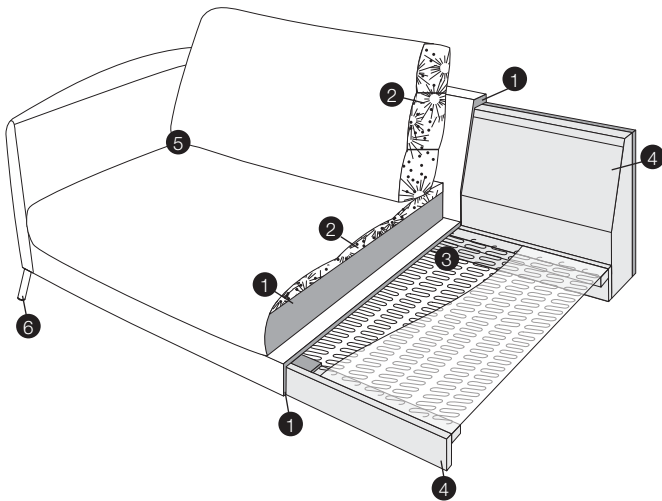

lux

1. polyurethane foam / high resilient polyurethane foam
2. cushion chamber with mix of feather and silicone balls
3. springs
4. solid wood and wood based elements
5. fabric
6. solid wood or metal legs

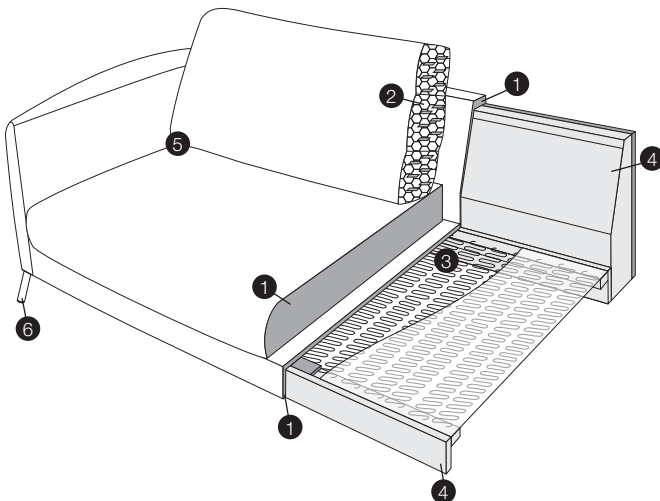

classic

1. polyurethane foam / high resilient polyurethane foam
2. foam flakes with silicone balls
3. springs
4. solid wood and wood based elements
5. fabric
6. solid wood or metal legs