

# Quattro

SITS



# Quattro

## UPHOLSTERY



fabric



leather

## COMFORTS



STD standard



LUX lux



CLS classic

## COVERS



FC fixed

## SPECIAL



sofa bed



modular system

Drawing show combinations with armrest 400. Combinantons with other armrest are properly longer or shorter in width.  
Cushions can be in fix cover in 70/90 version.  
Drawings shown height with leg no. 51 H-10.

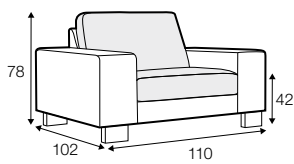

armchair 71

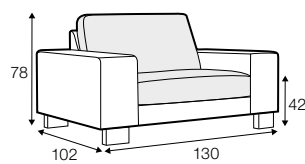

armchair 91

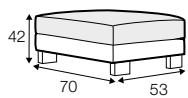

footstool 70x53  
version 91x71

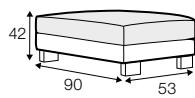

footstool 90x53  
version 91x71

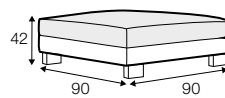

footstool 90x90  
version 91x71

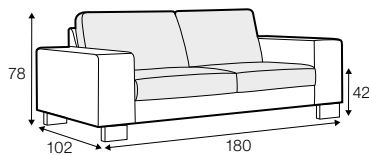

2 seater 71

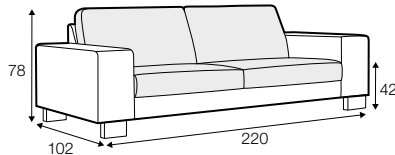

3 seater 91

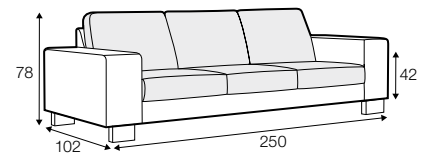

3 seater XL 71

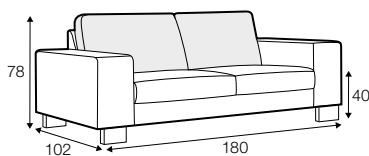

sofa bed

standard comfort - only version 70 for fabric and leather

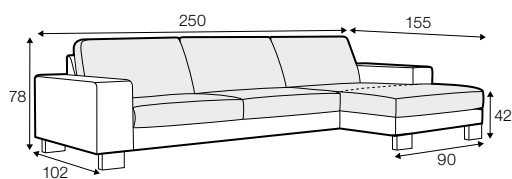
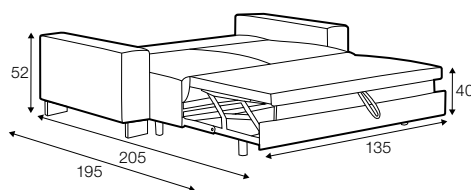

set 1 right / or left

2 seater 71 left / or right + chaiselongue 71 right / or left

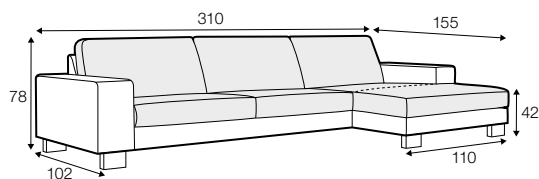

set 2 right / or left

3 seater 91 left / or right + chaiselongue 91 right / or left

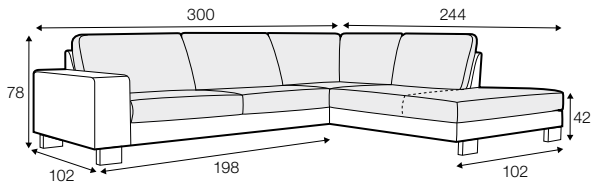

**set 14 right / or left**

3 seater 91 left / or right + corner 90° no. 320  
+ bench 71 right / or left

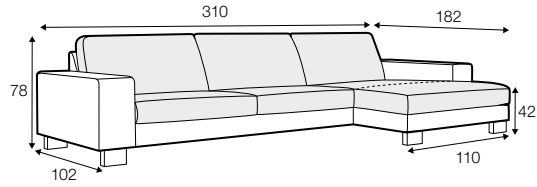

**set 16 right / or left**

3 seater 91 left / or right + chaiselongue 91 long right / or left

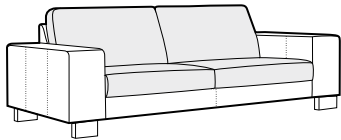

example of leather cover  
3 seater 91

**modular system**

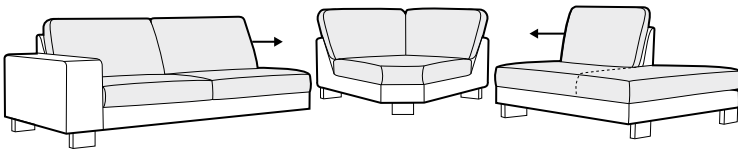

**elements of the modular system**

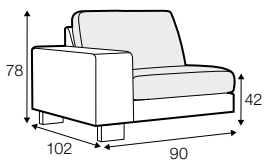

armchair 71  
left / or right

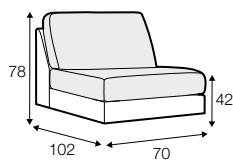

armchair 71  
without armrests

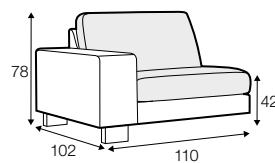

armchair 91  
left / or right

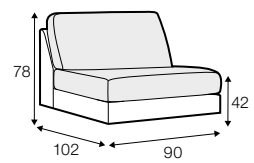

armchair 91  
without armrests

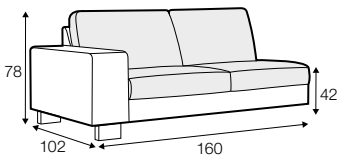

2 seater 71 left / or right

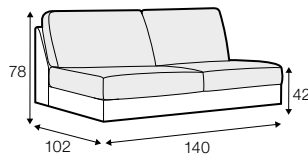

2 seater 71 without armrests

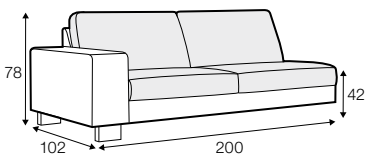

3 seater 91 left / or right

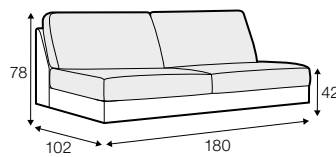

3 seater 91 without armrests

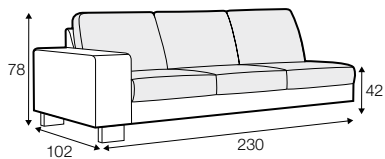

3 seater XL 71 left / or right

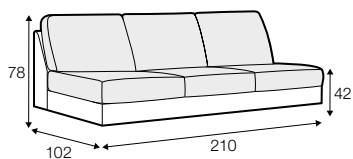

3 seater XL 71 without armrests

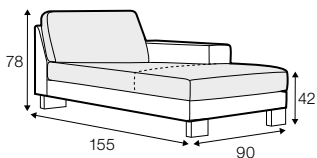

chaiselongue 71 right / or left

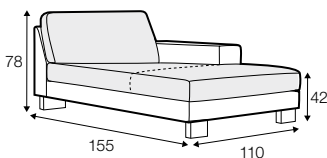

chaiselongue 91 right / or left

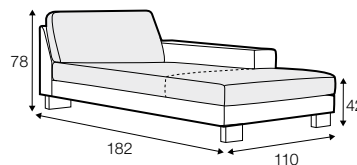

chaiselongue 91 long right / or left

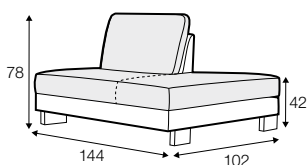

bench 71 right / or left

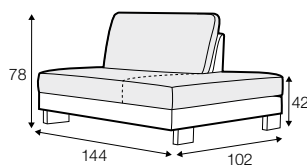

bench 91 right / or left

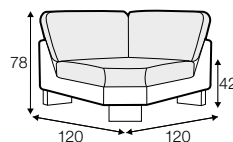

corner 90° no. 310

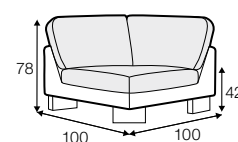

corner 90° no. 320

## extra dimensions

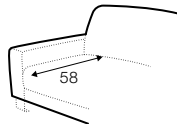

depth of seat

## accessories

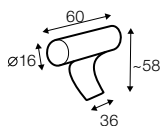
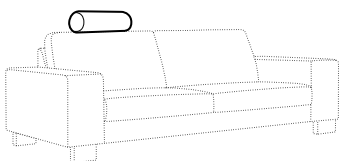

headrest with roll L-60  
The headrest is available only in  
STANDARD/CLASSIC comfort

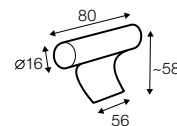
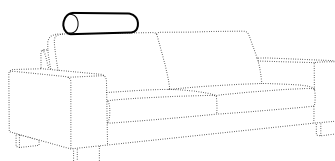

headrest with roll L-80  
The headrest is available only in  
STANDARD/CLASSIC comfort

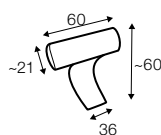
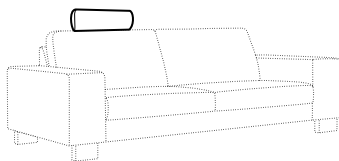

headrest L-60  
The headrest is available in  
LUX & STANDARD/CLASSIC comfort

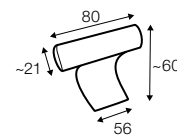
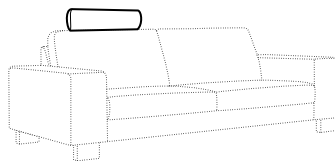

headrest L-80  
The headrest is available in  
LUX & STANDARD/CLASSIC comfort

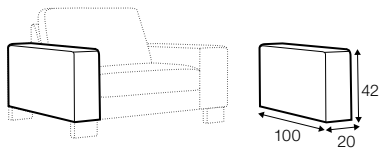

armrest 400

100x20x42

available with feet:

no. 47, no. 51, no. 145A, no. 176

legs to SB H-100:

all above

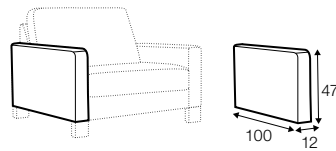

armrest 450

100x12x47

available with feet:

no. 47, no. 51, no. 145B, no. 176

legs to SB H-100:

no. 145B, no. 176

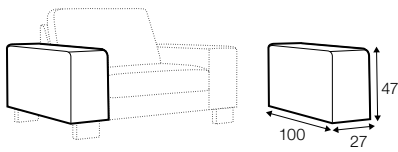

armrest 460

100x27x47

available with feet:

no. 47, no. 51, no. 145A, no. 176

legs to SB H-100:

all above

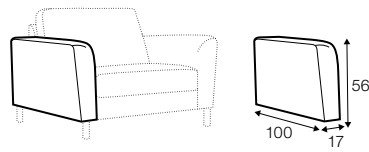

armrest 480

100x17x56

available with feet:

no. 47, no. 51, no. 145B, no. 176

legs to SB H-100:

no. 145B, no. 176

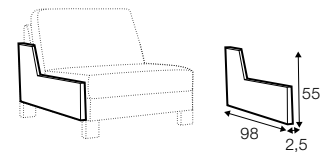

endpart left / or right

## legs

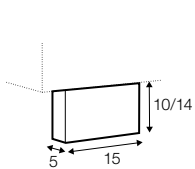

no. 51

wood

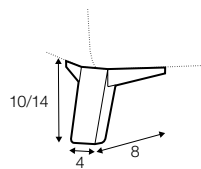

no. 176

wood

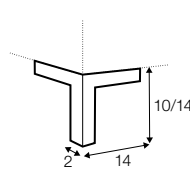

no. 47

metal chrome,  
painted black

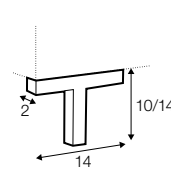

no. 47A

metal chrome,  
painted black

(only for corners)

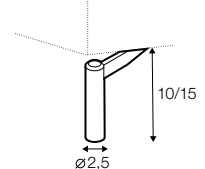

no. 145A

metal chrome,  
painted black

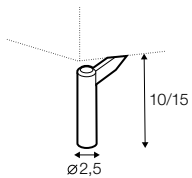

no. 145B

metal chrome,  
painted black

## profile

---

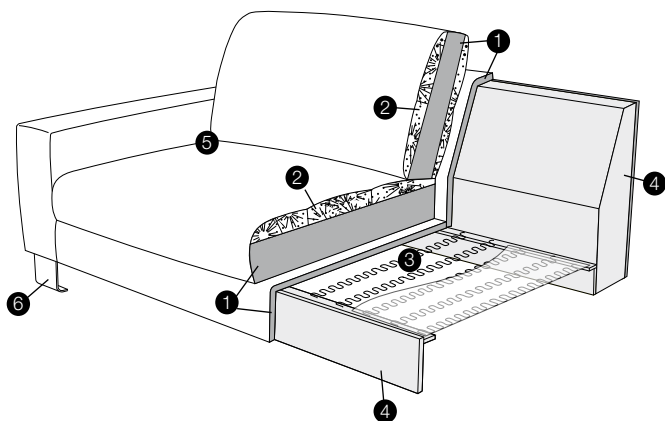

### lux

1. polyurethane foam/ high resilient polyurethane foam
2. cushion chamber with mix of feather and silicone balls
3. springs
4. solid wood and wood based elements
5. fabric or leather
6. solid wood or metal legs

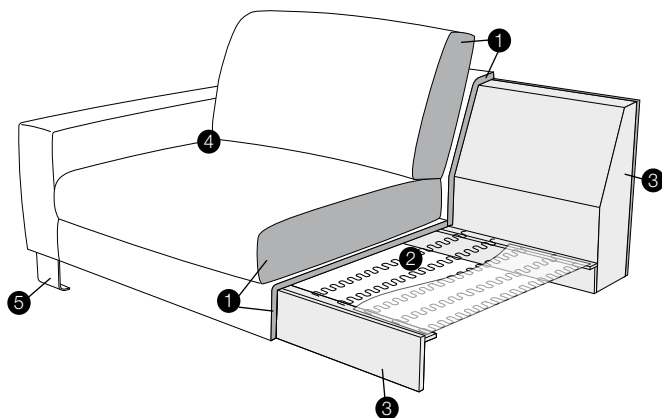

### standard

1. polyurethane foam/ high resilient polyurethane foam
2. springs
3. solid wood and wood based elements
4. fabric or leather
5. solid wood or metal legs

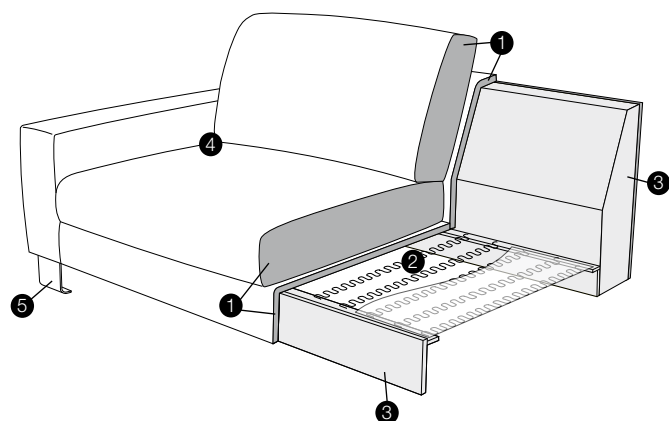

### classic

1. polyurethane foam/ high resilient polyurethane foam
2. springs
3. solid wood and wood based elements
4. fabric or leather
5. solid wood or metal legs