

Vera

SITS



Vera

I Archer
designed by: Ian Archer



UPHOLSTERY



fabric

COMFORTS



STD standard



LUX lux

COVERS



FC fixed

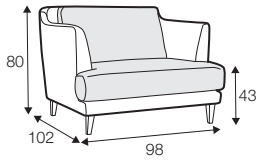

armchair

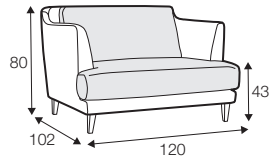

love seat

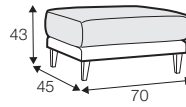

footstool 70x45

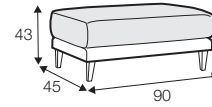

footstool 90x45

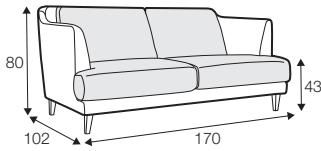

2 seater

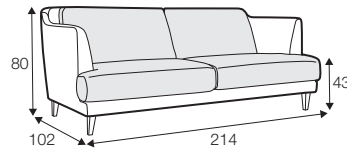

3 seater

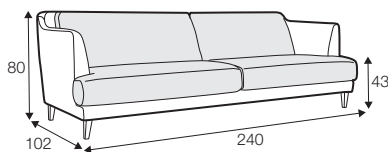

3XL seater
with 2 cushions

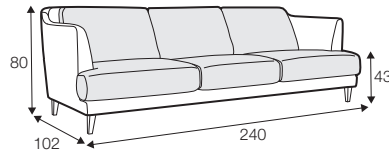

3XL seater
with 3 cushions

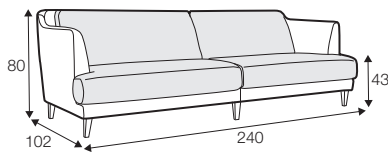

3XL seater divided
with 2 cushions

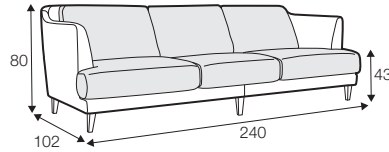

3XL seater divided
with 3 cushions

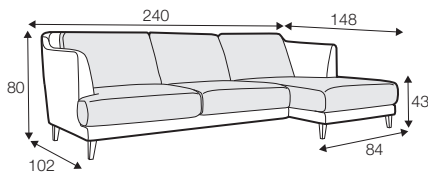

set 1 right / or left

2 seater left / or right + chaiselongue right / or left

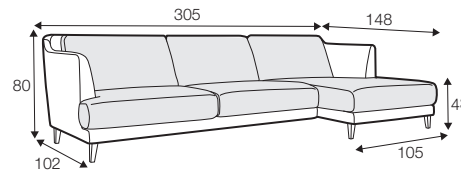

set 2 right / or left

3 seater left / or right + chaiselongue wide right / or left

extra dimensions

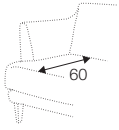

depth of seat

accessories

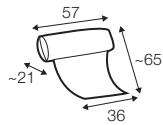
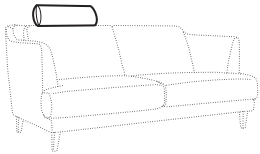

headrest L-57

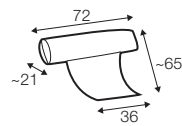
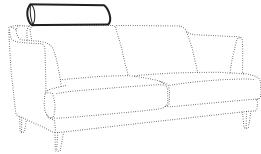

headrest L-72

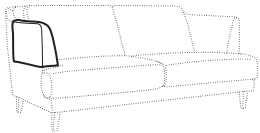

armrest protection

legs

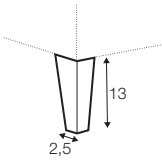

no. 201
wood

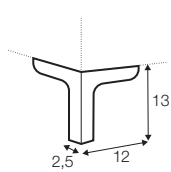

no. 202
metal chrome,
painted black

profile

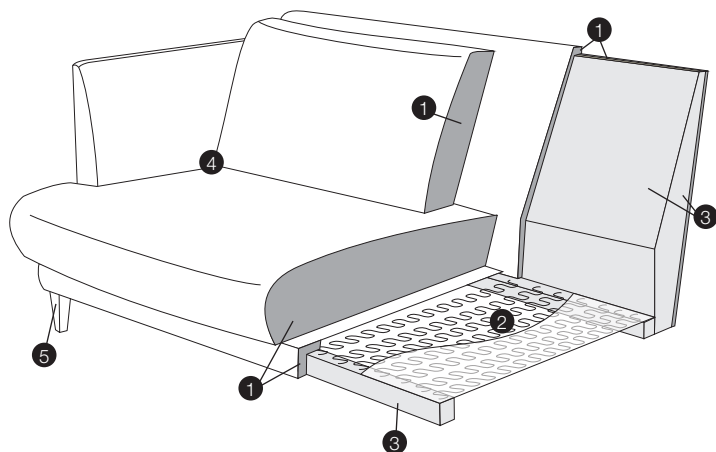

standard

1. polyurethane foam / high resilient polyurethane foam
2. springs
3. solid wood and wood based elements
4. fabric
5. solid wood or metal legs

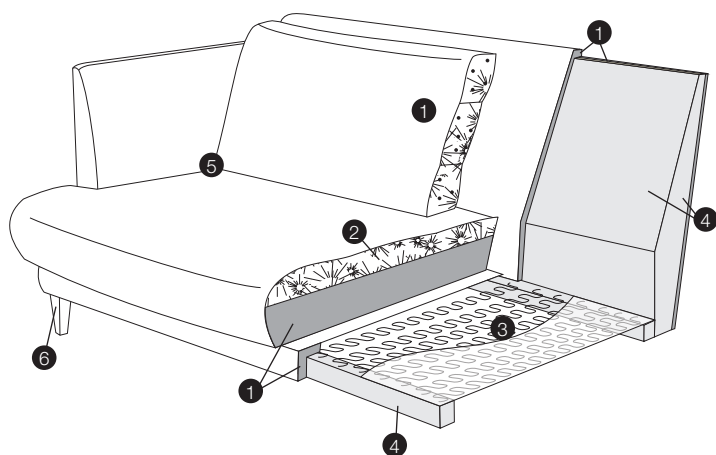

lux

1. polyurethane foam / high resilient polyurethane foam
2. cushion chamber with mix of feather and silicone balls
3. springs
4. solid wood and wood based elements
5. fabric
6. solid wood or metal legs